

Network Address Translation (NAT)

Relates to Lab 7.

Module about private networks and NAT.

Taken from [http://www.cs.virginia.edu/~itlab/
book/slides/module17-nat.ppt](http://www.cs.virginia.edu/~itlab/book/slides/module17-nat.ppt)

Private Network

- *Private IP* network is an IP network that is not directly connected to the Internet
- IP addresses in a private network can be assigned arbitrarily.
 - Not registered and not guaranteed to be globally unique
- Generally, private networks use addresses from the following experimental address ranges (*non-routable addresses*):
 - 10.0.0.0 – 10.255.255.255
 - 172.16.0.0 – 172.31.255.255
 - 192.168.0.0 – 192.168.255.255

Private Addresses

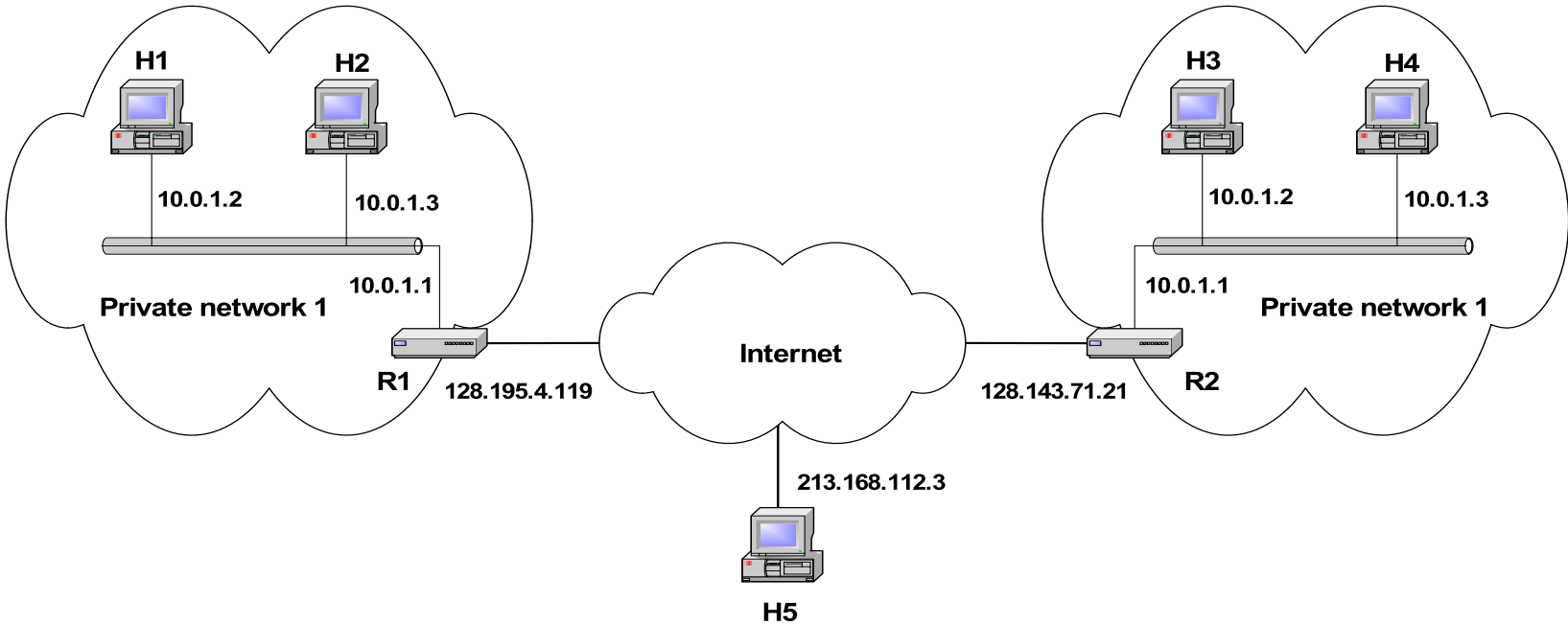

Network Address Translation (NAT)

- NAT is a router function where IP addresses (and possibly port numbers) of IP datagrams are replaced at the boundary of a private network
- NAT is a method that enables hosts on private networks to communicate with hosts on the Internet
- NAT is run on routers that connect private networks to the public Internet, to replace the IP address-port pair of an IP packet with another IP address-port pair.

Basic operation of NAT

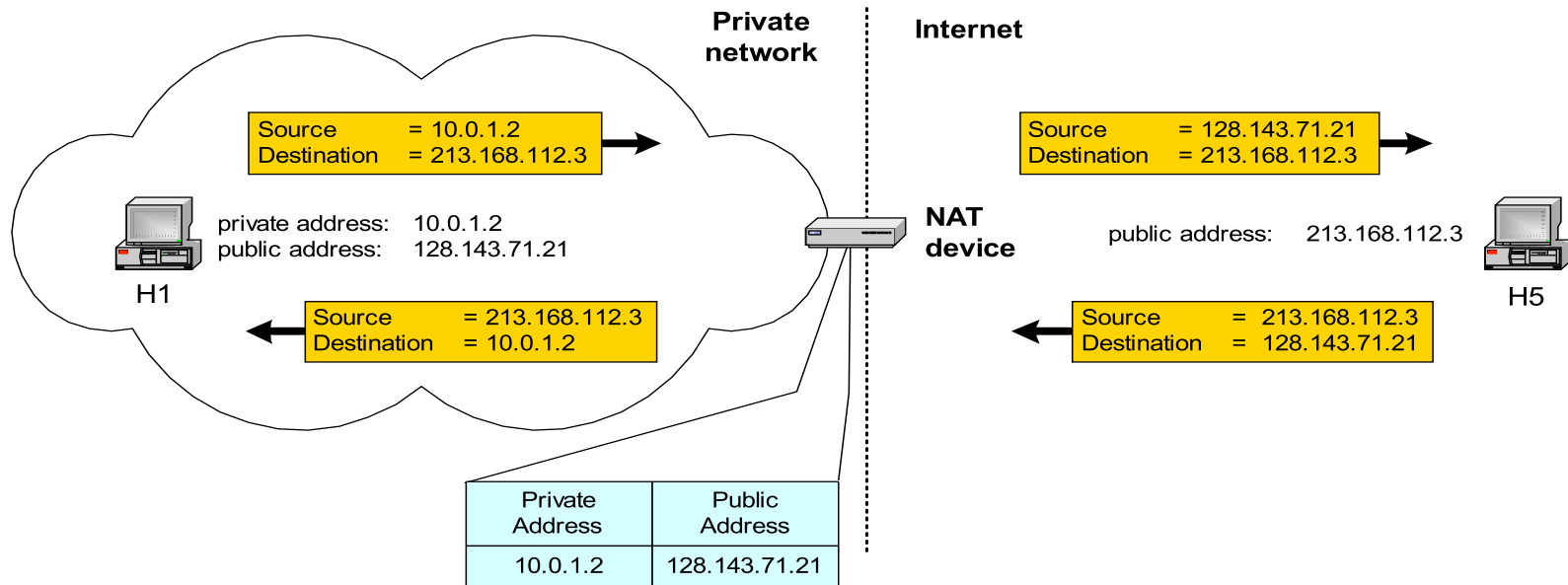

- NAT device has address translation table

Pooling of IP addresses

- **Scenario:** Corporate network has many hosts but only a small number of public IP addresses
- **NAT solution:**
 - Corporate network is managed with a private address space
 - NAT device, located at the boundary between the corporate network and the public Internet, manages a pool of public IP addresses
 - When a host from the corporate network sends an IP datagram to a host in the public Internet, the NAT device picks a public IP address from the address pool, and binds this address to the private address of the host

Pooling of IP addresses

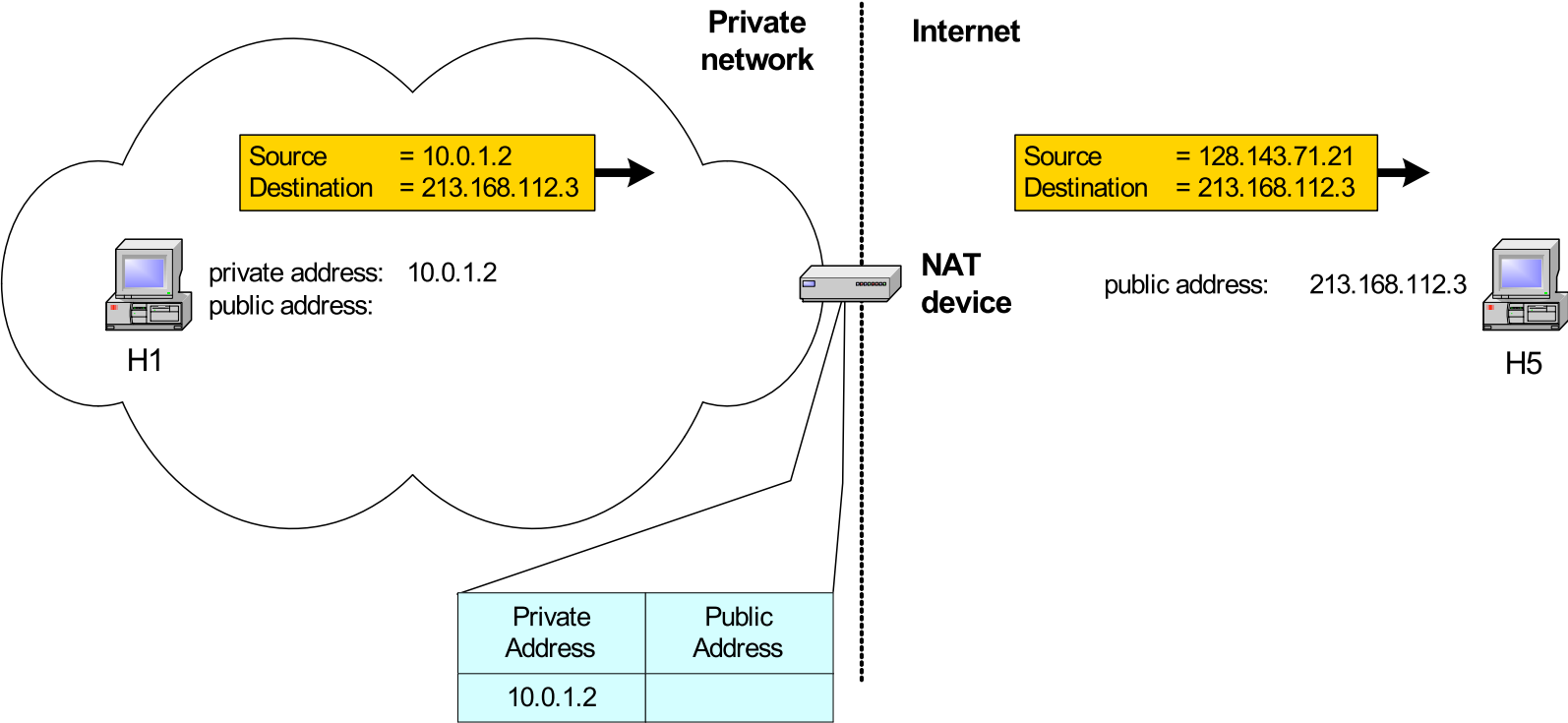

Pool of addresses: 128.143.71.0-128.143.71.30

Supporting migration between network service providers

- **Scenario:** In CIDR, the IP addresses in a corporate network are obtained from the service provider. Changing the service provider requires changing all IP addresses in the network.
- **NAT solution:**
 - Assign private addresses to the hosts of the corporate network
 - NAT device has static address translation entries which bind the private address of a host to the public address.
 - Migration to a new network service provider merely requires an update of the NAT device. The migration is not noticeable to the hosts on the network.

Note:

- The difference to the use of NAT with IP address pooling is that the mapping of public and private IP addresses is static.

Supporting migration between network service providers

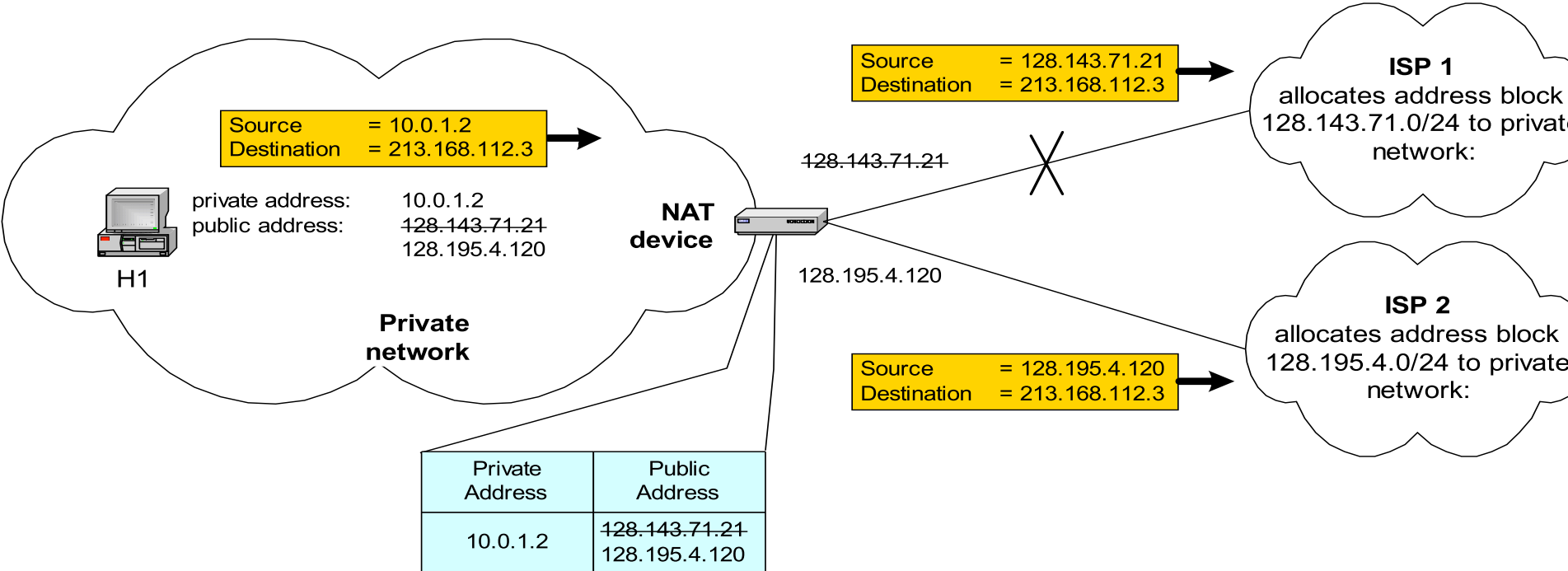

IP masquerading

- **Also called: Network address and port translation (NAPT), port address translation (PAT).**
- **Scenario:** Single public IP address is mapped to multiple hosts in a private network.
- **NAT solution:**
 - Assign private addresses to the hosts of the corporate network
 - NAT device modifies the port numbers for outgoing traffic

IP masquerading

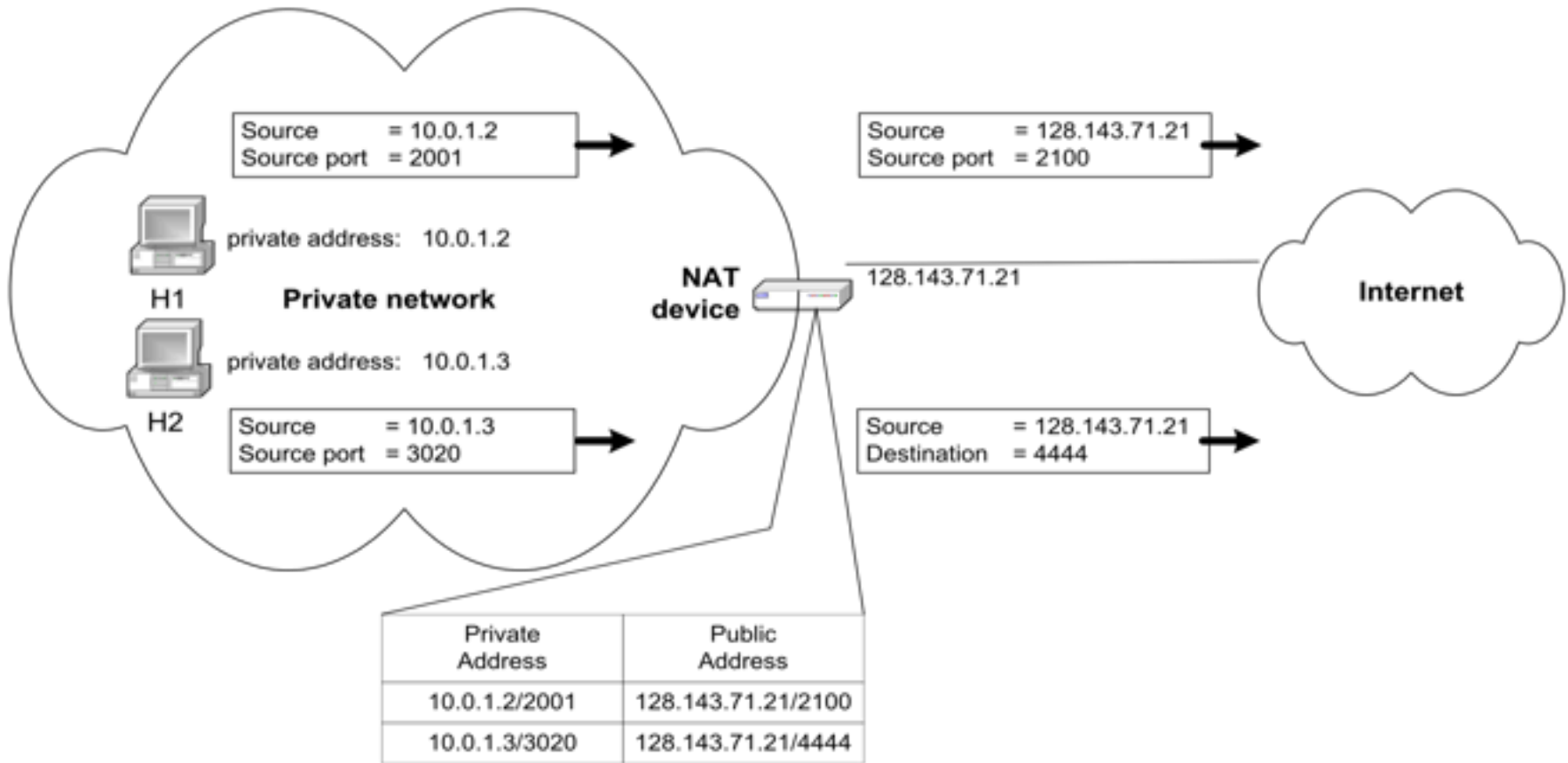

Load balancing of servers

- **Scenario:** Balance the load on a set of identical servers, which are accessible from a single IP address
- **NAT solution:**
 - Here, the servers are assigned private addresses
 - NAT device acts as a proxy for requests to the server from the public network
 - The NAT device changes the destination IP address of arriving packets to one of the private addresses for a server
 - A sensible strategy for balancing the load of the servers is to assign the addresses of the servers in a round-robin fashion.

Load balancing of servers

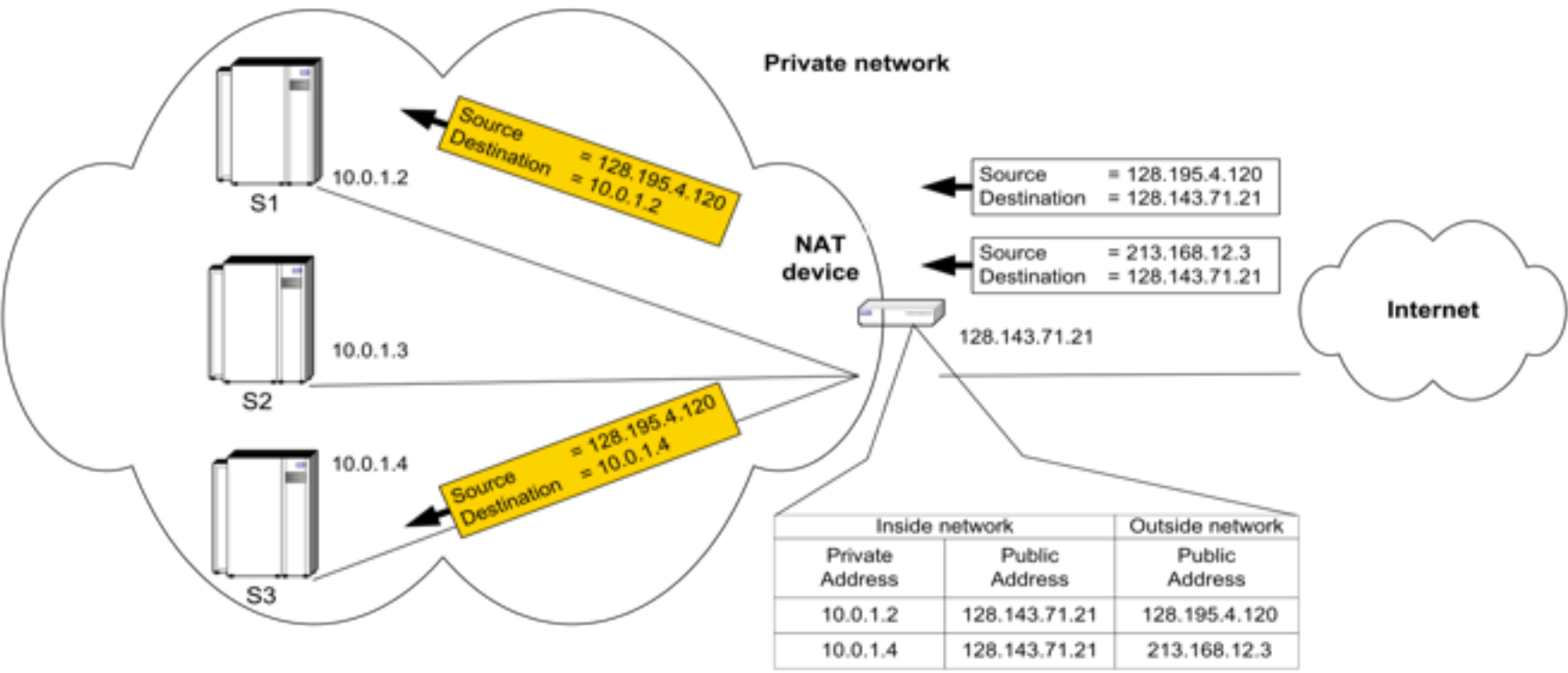

Concerns about NAT

- **Performance:**
 - Modifying the IP header by changing the IP address requires that NAT boxes recalculate the IP header checksum
 - Modifying port number requires that NAT boxes recalculate TCP checksum
- **Fragmentation**
 - Care must be taken that a datagram that is fragmented before it reaches the NAT device, is not assigned a different IP address or different port numbers for each of the fragments.

Concerns about NAT

- **End-to-end connectivity:**
 - NAT destroys universal end-to-end reachability of hosts on the Internet.
 - A host in the public Internet often cannot initiate communication to a host in a private network.
 - The problem is worse, when two hosts that are in a private network need to communicate with each other.

Concerns about NAT

- **IP address in application data:**
 - Applications that carry IP addresses in the payload of the application data generally do not work across a private-public network boundary.
 - Some NAT devices inspect the payload of widely used application layer protocols and, if an IP address is detected in the application-layer header or the application payload, translate the address according to the address translation table.

NAT and FTP

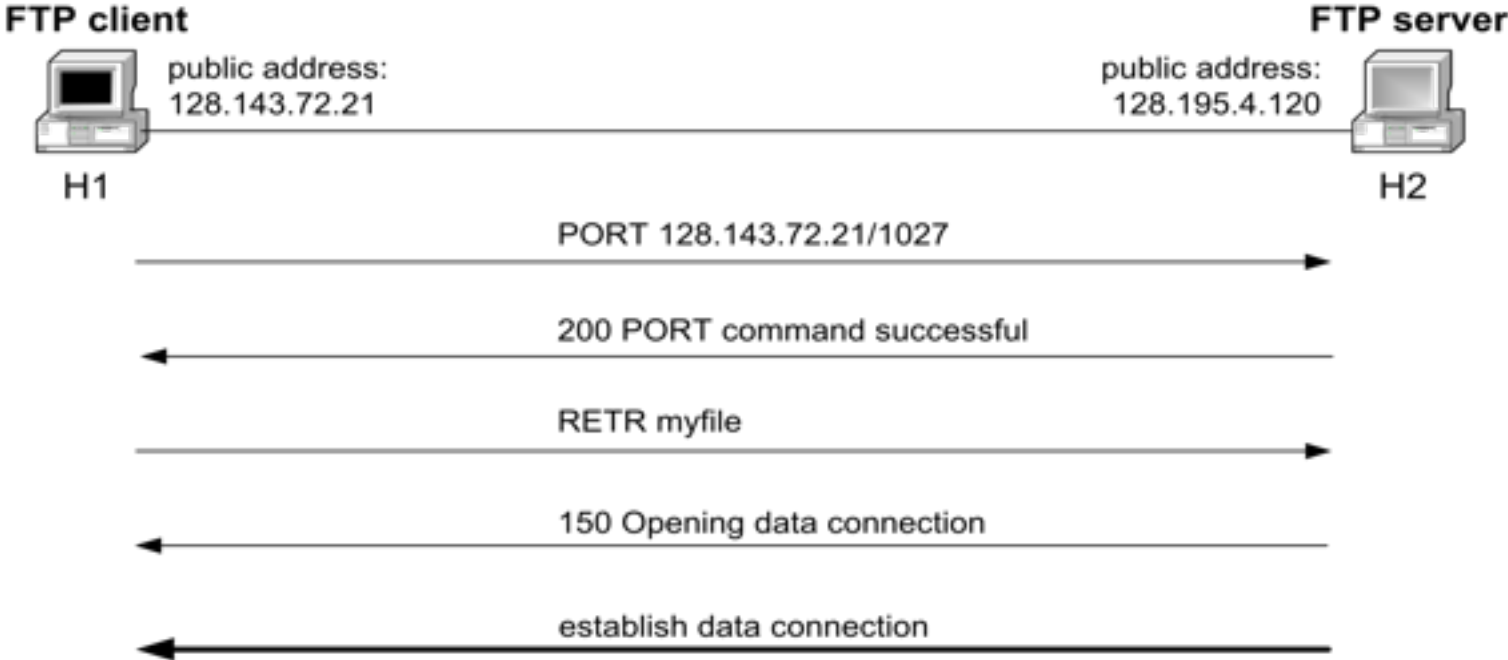

- Normal FTP operation

NAT and FTP

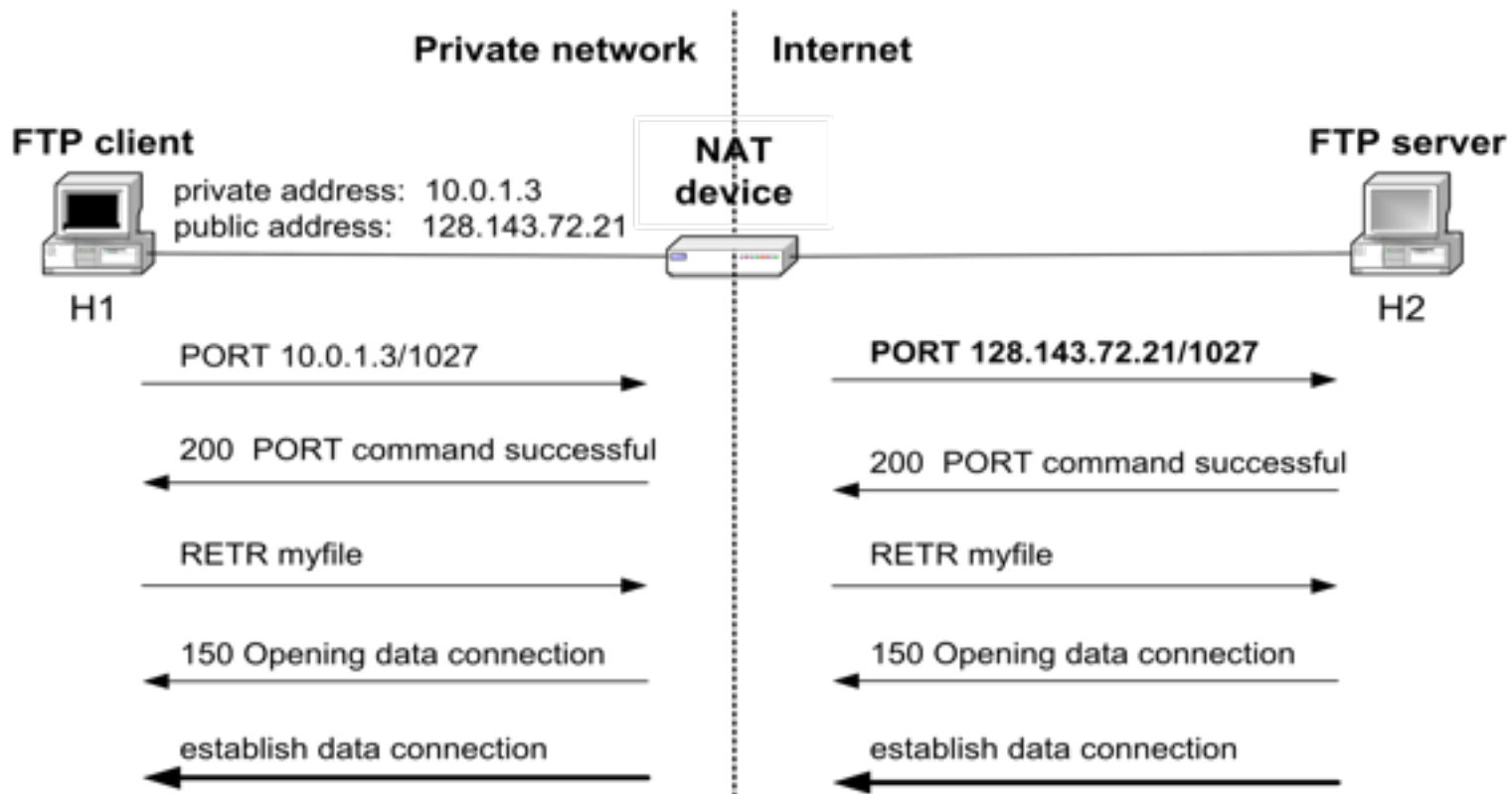

- NAT device with FTP support

NAT and FTP

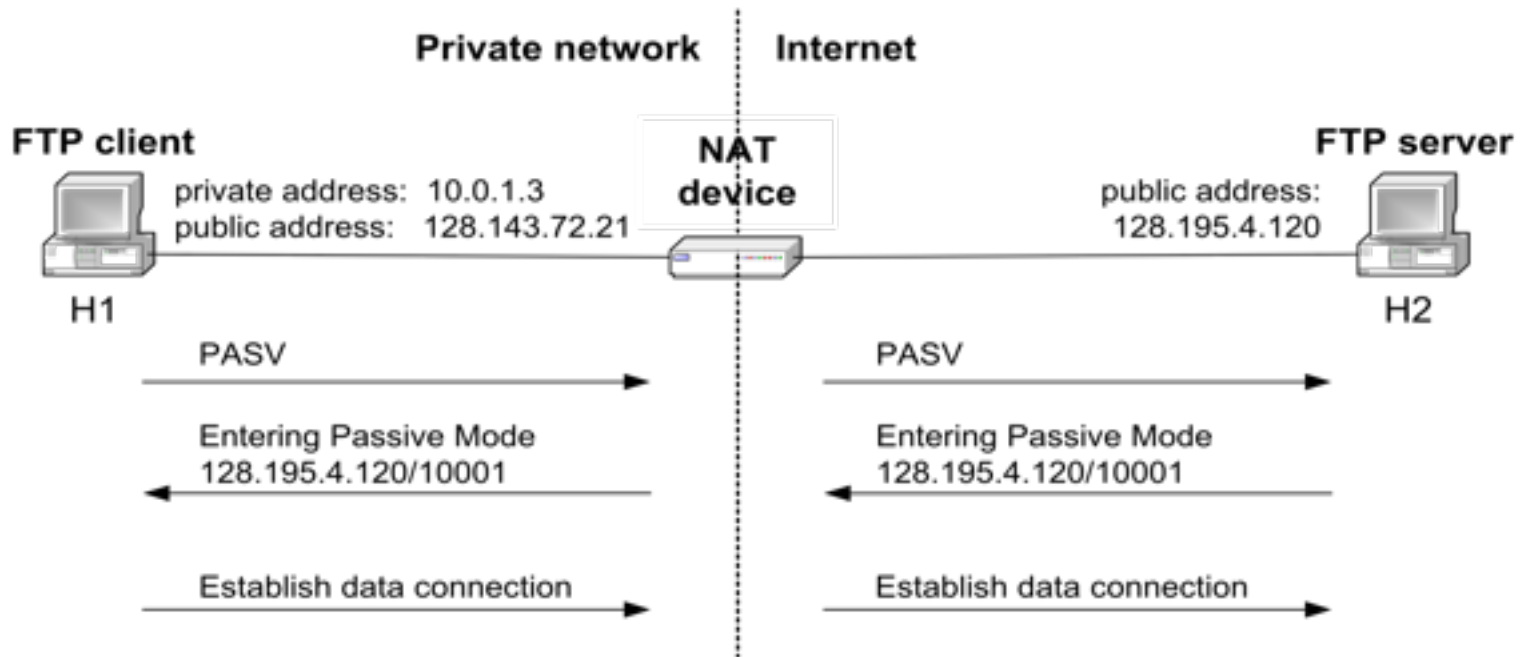

- FTP in passive mode and NAT.